

# Lärdomar från användning av sensorteknik i dagvattenreningsanläggningar

**VAK 2024**

Glen Nivert

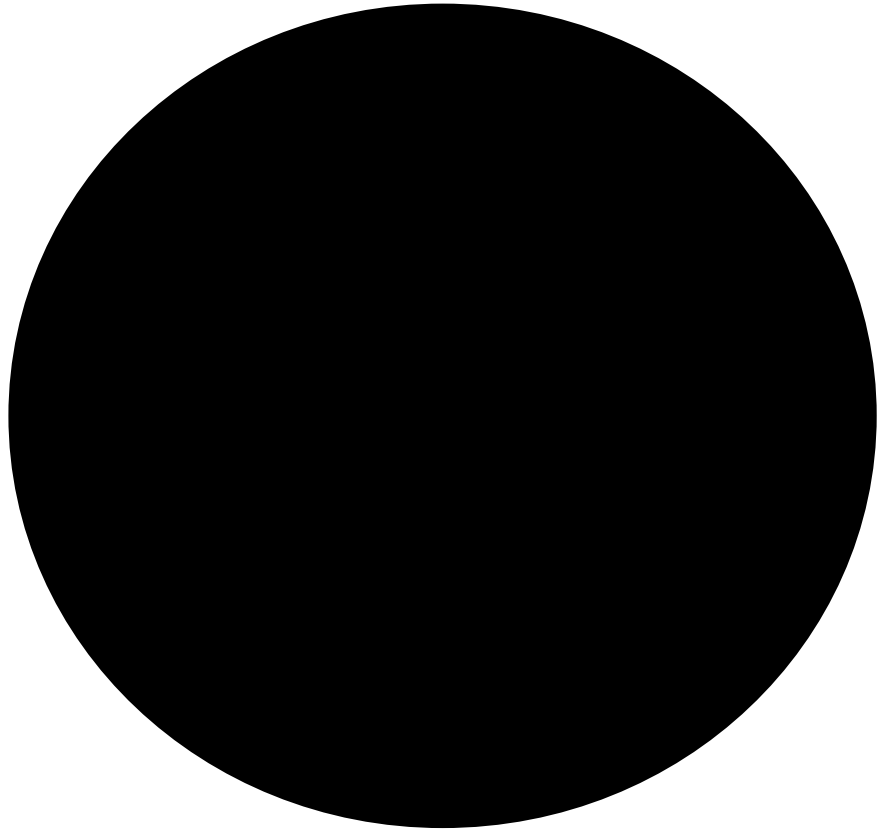



70-talet



90-talet



2010-talet



Rogers Adaptionkurva



# Why?



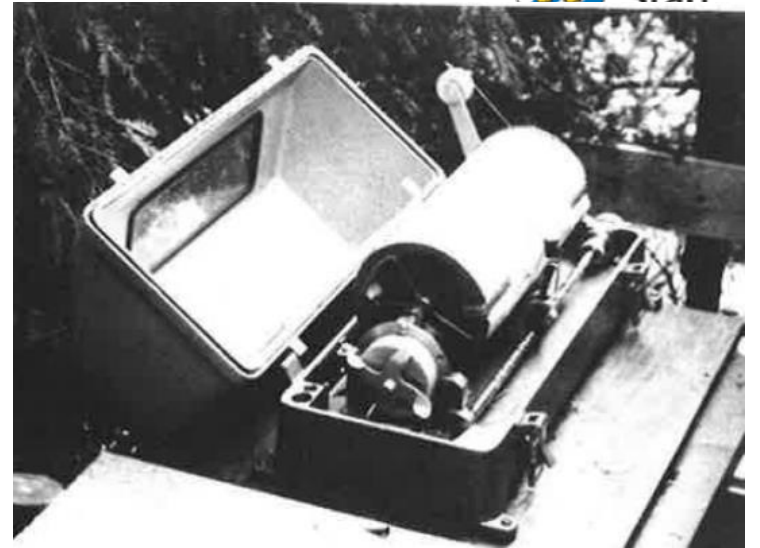

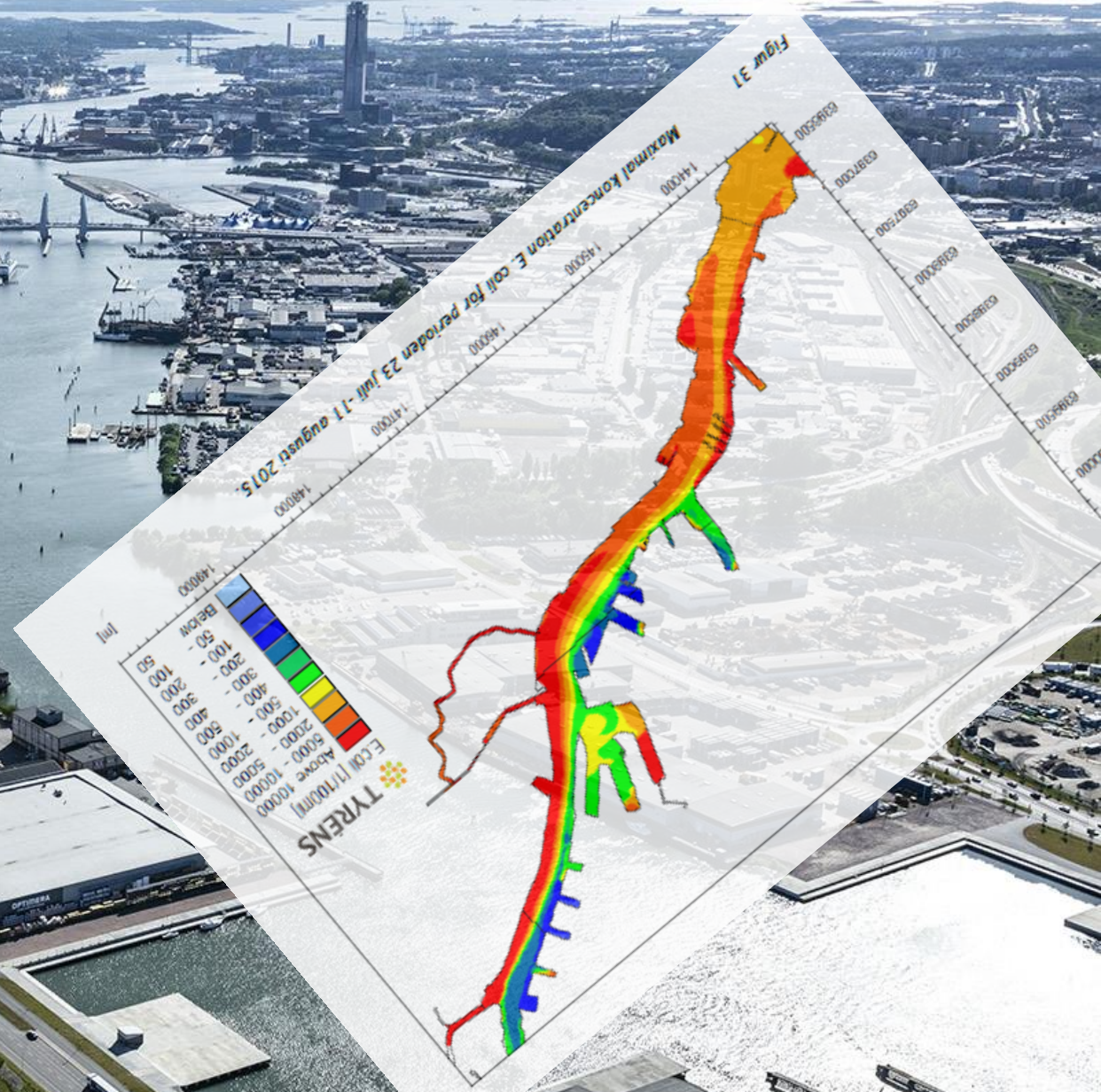
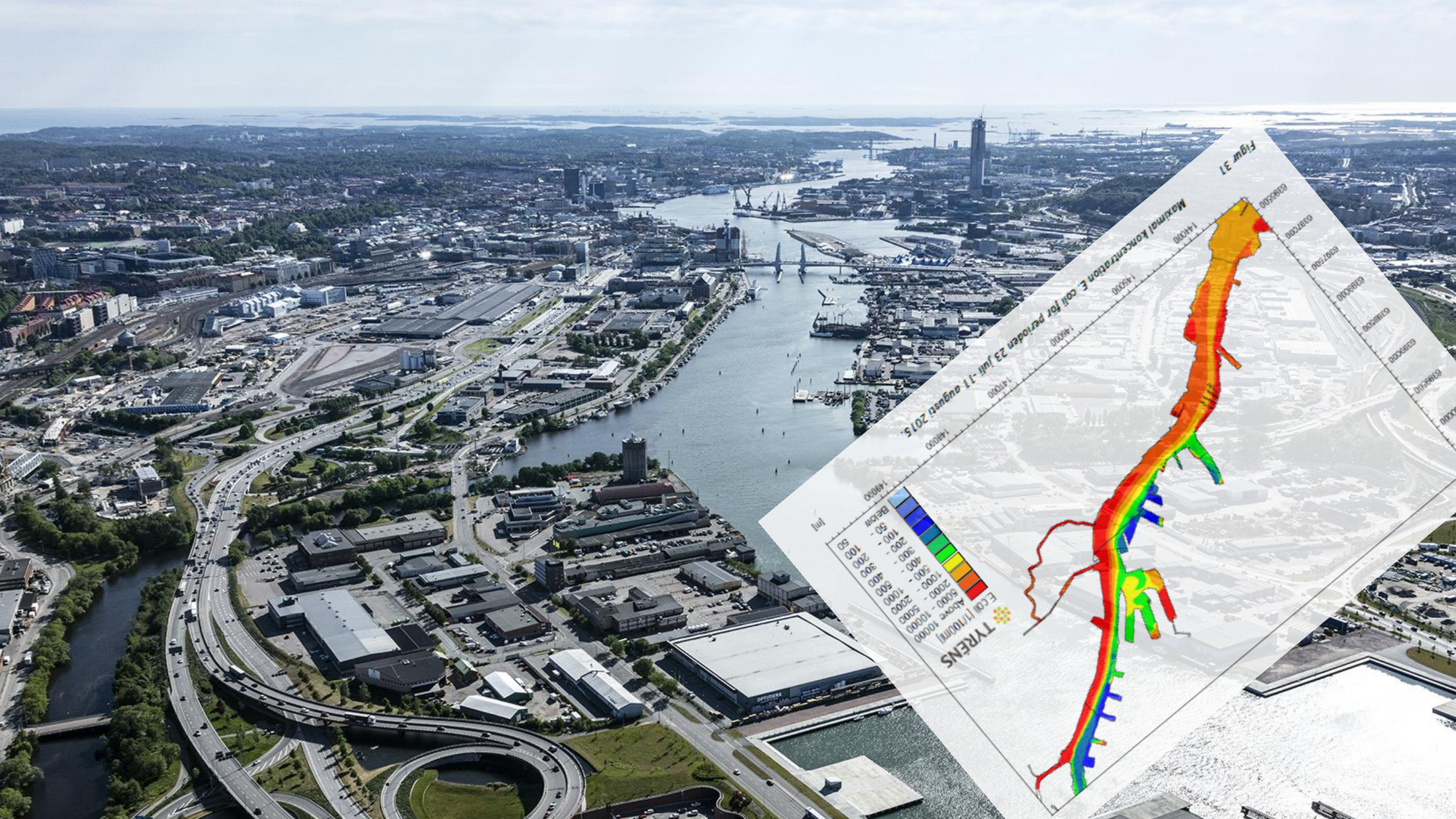

# Exempel



# Rännstensbrunnar



## MÄTPRINCIPEN

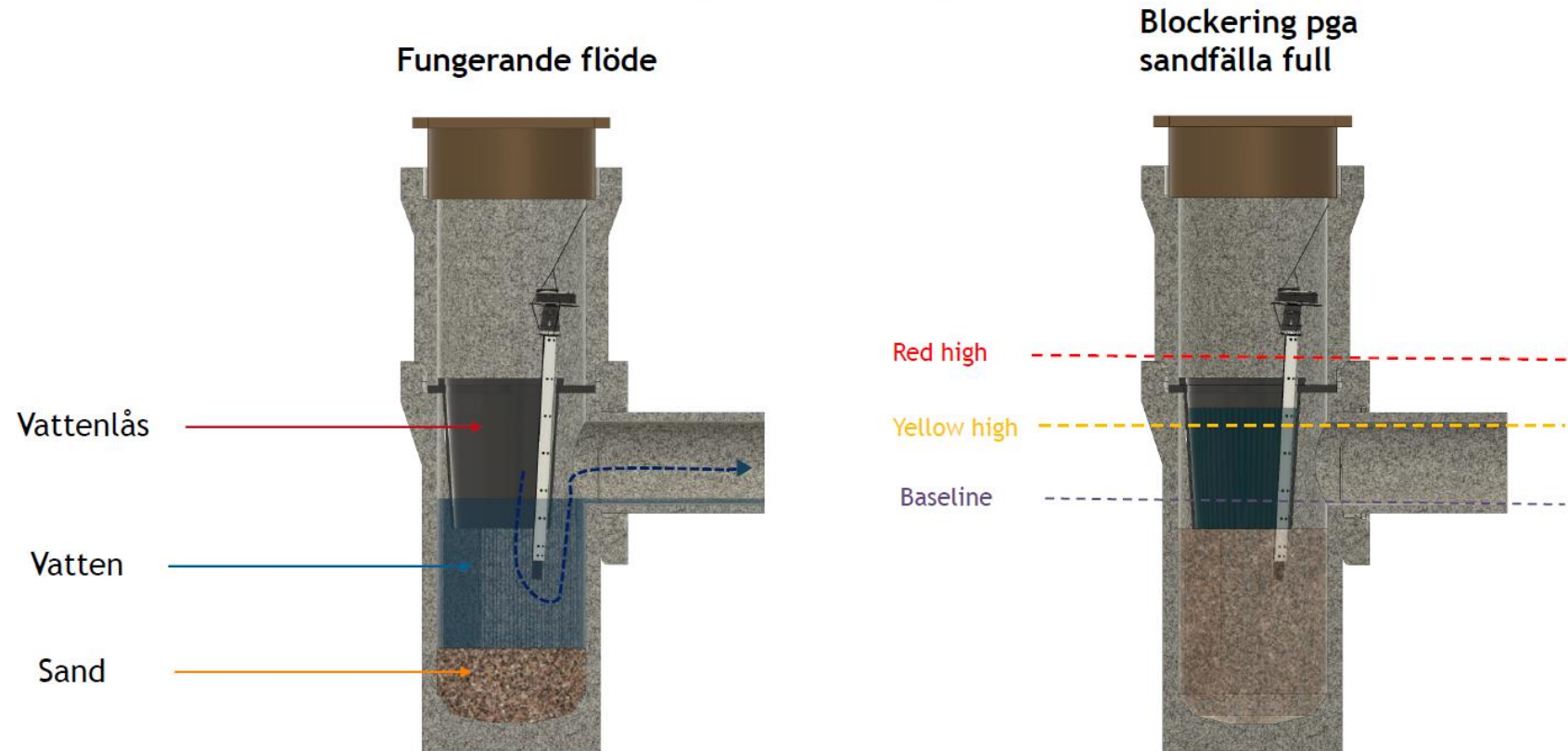

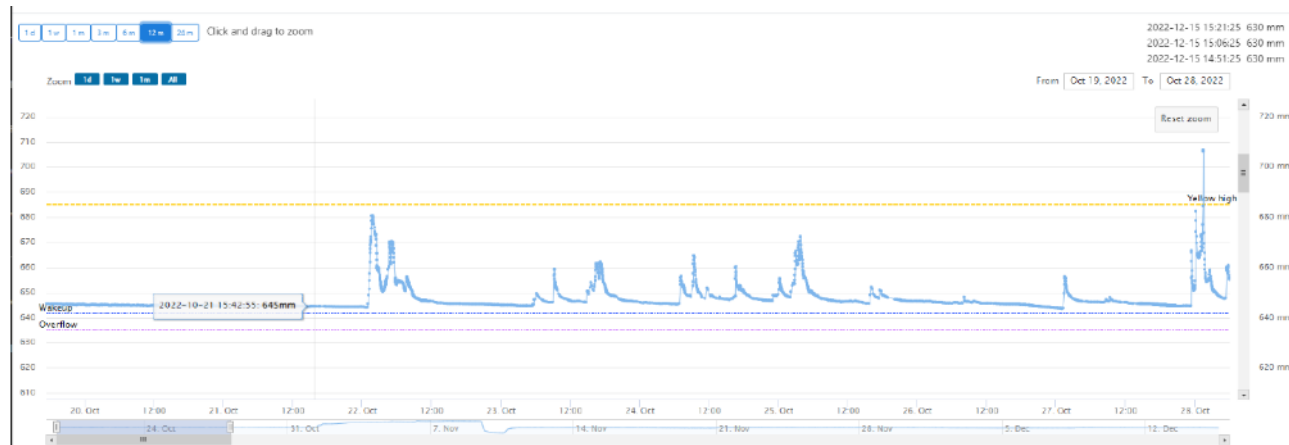

Testbrunn Rännstensor - 3635363064396315 / 1759

# Fler nya "Tekniska filteranläggningar"

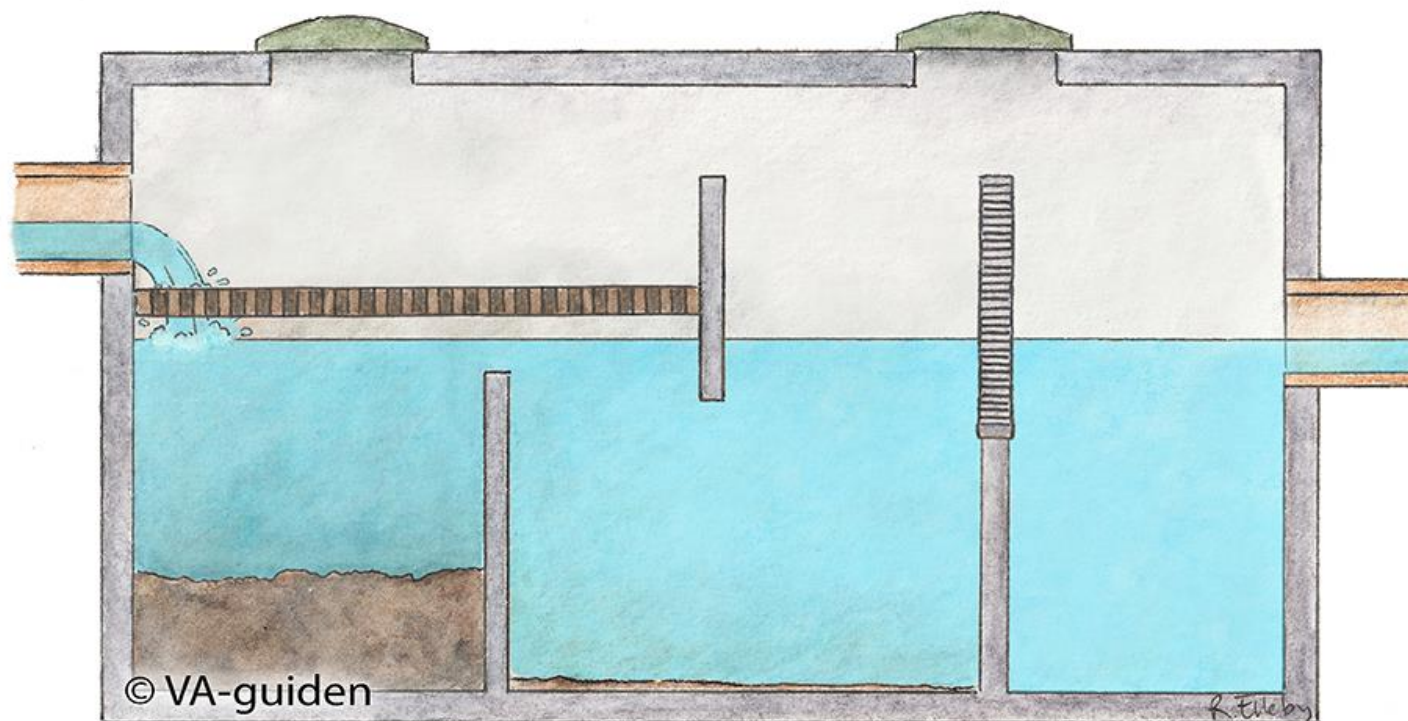

# Vitsippsbäcken pilotanläggning

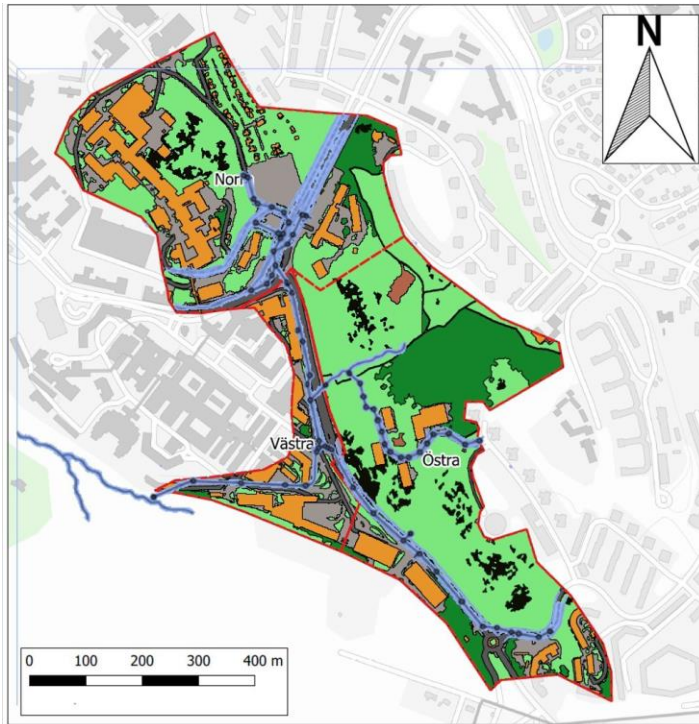

- 45ha

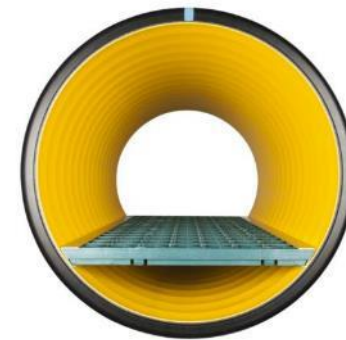
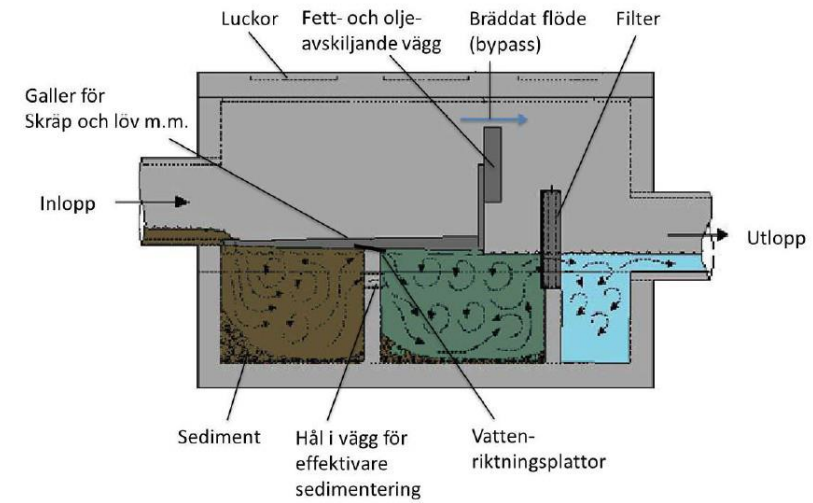

- Flödesfördelning
- pH
- Susp
- Turbiditet
- Konduktivitet
- Slamnivå
- Olja

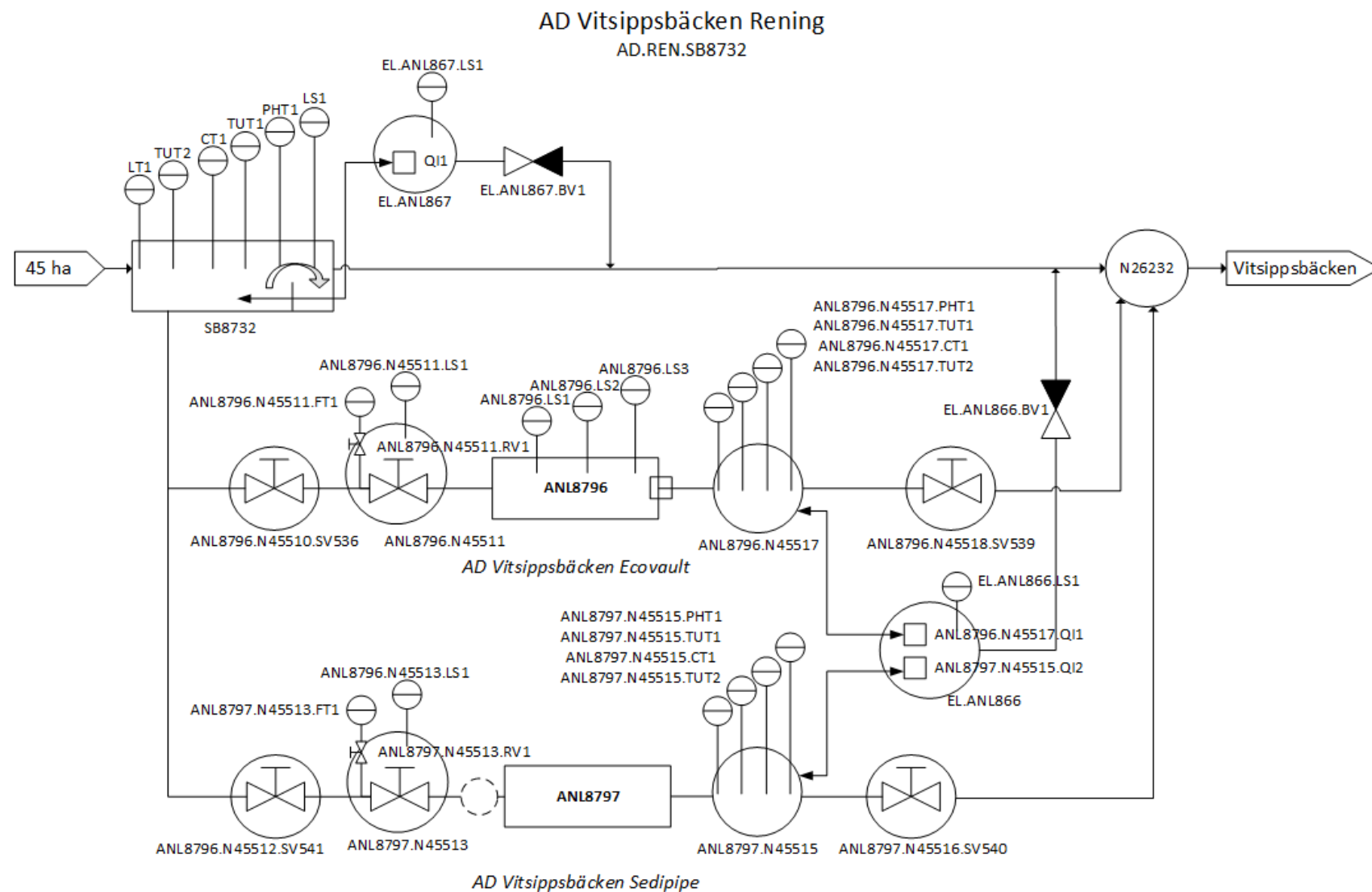

# Kryddvägen kontroll av sedimenteringen



Inlopp damm

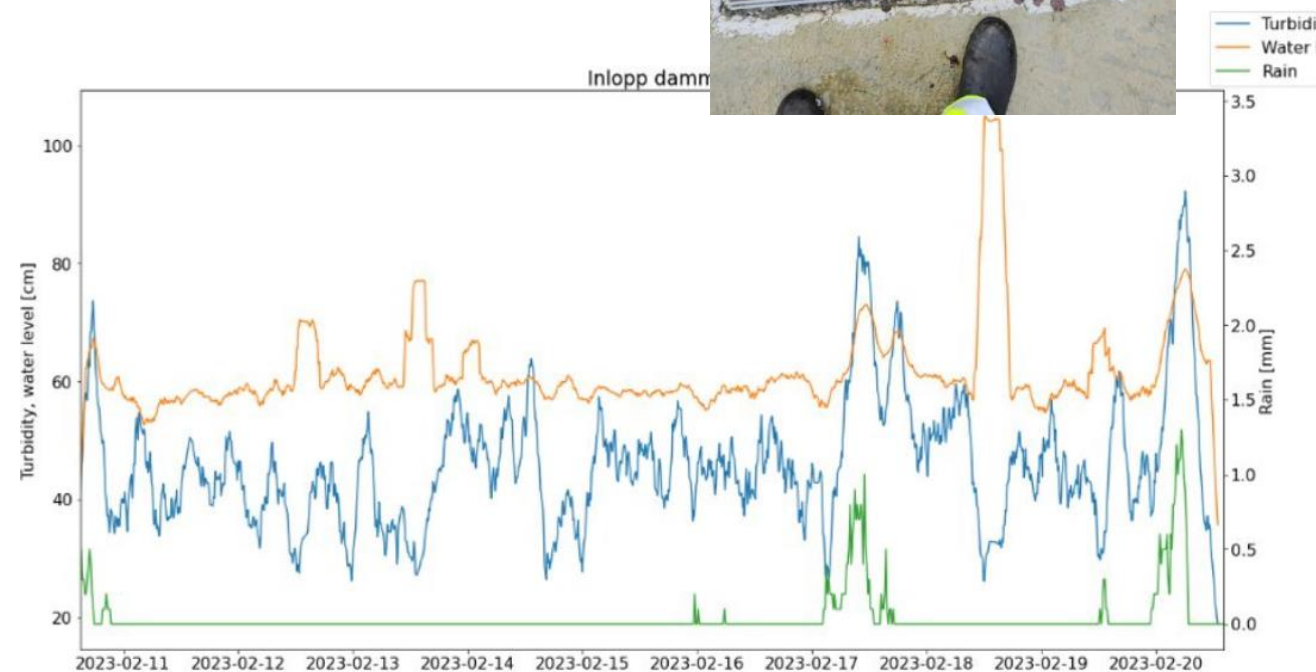

# Magasin Olofasklundsgata

- Optimering av rening av dam genom styrning av magasin
- Styrbar ventil
- Nivåmätare
- Nederbörds prognos

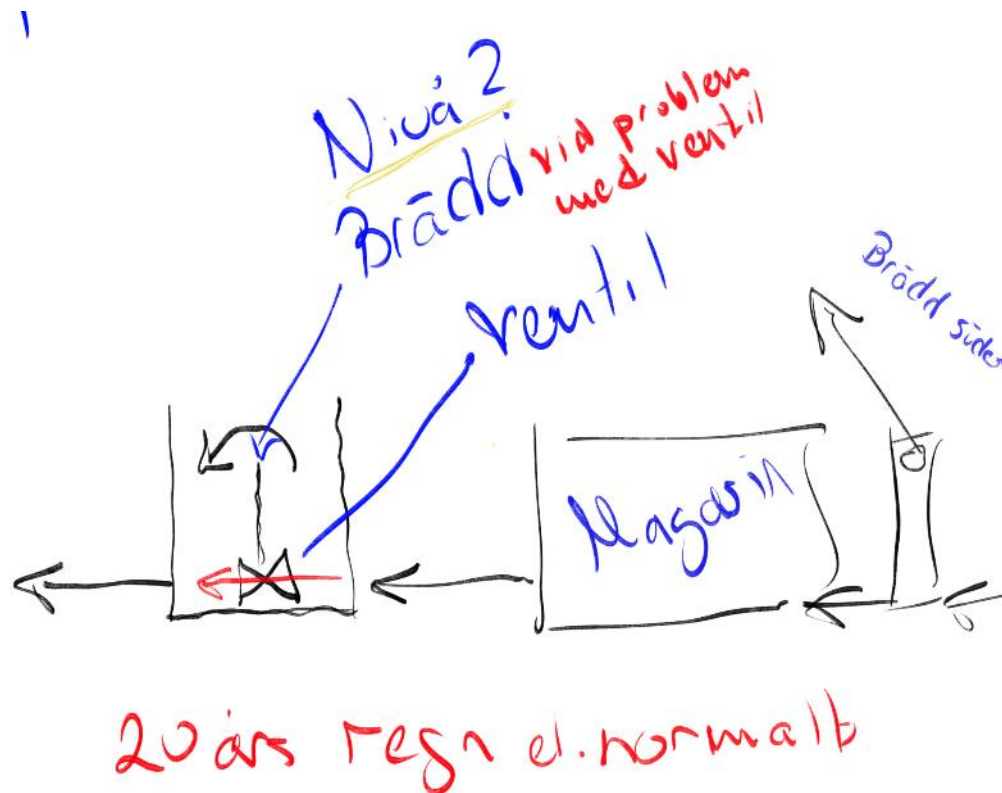

# Kontroll/intrimning av dimensionering av fördröjnings magasin

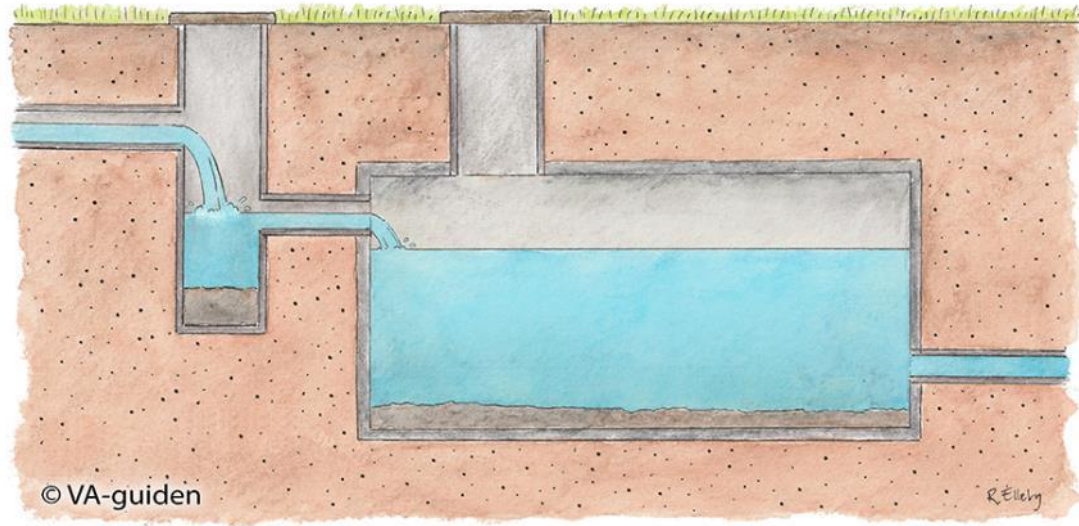



# BB/NU mätning

- Möta bla kommande krav samt förbättra FU/avhjälpande underhåll.

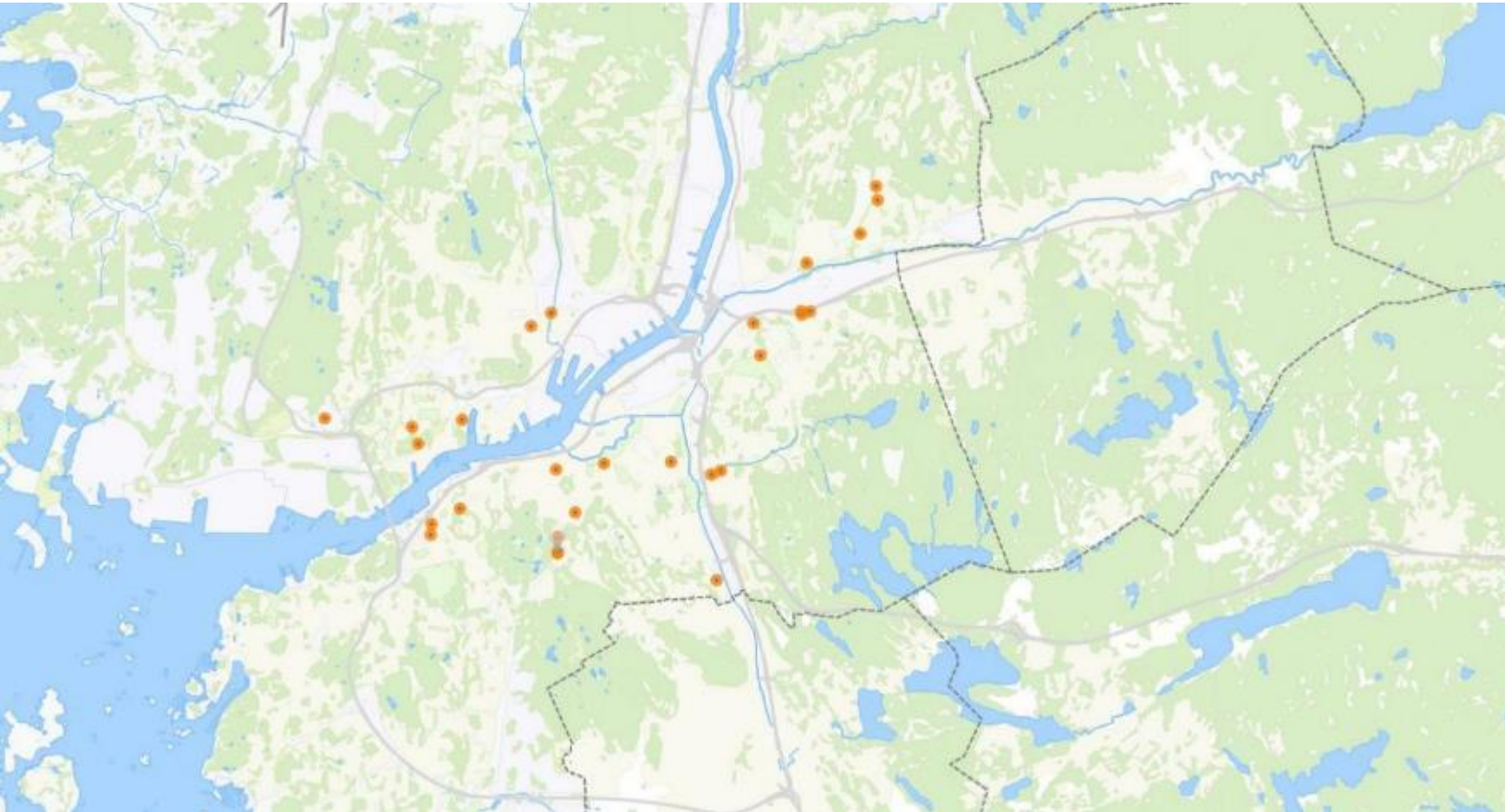

# Nederbördsrätmätare/regnmätare

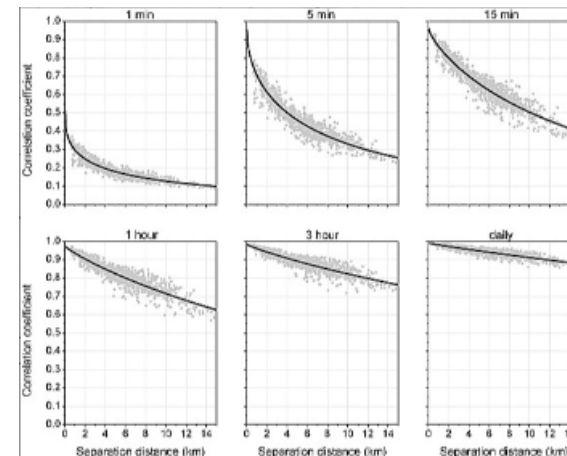
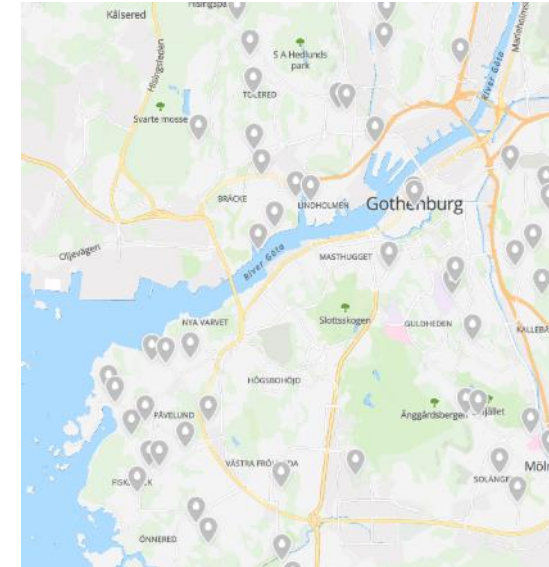
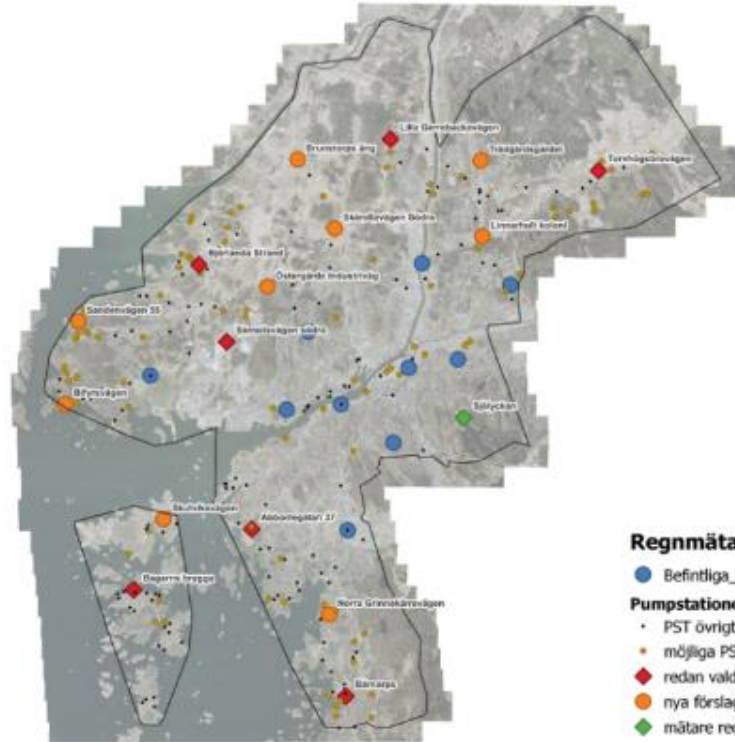

# Hinder

- Teknik/kostnad - kvalitetsmätning
- Resurser
- IT infrastruktur
- Kompetens
  - IT
  - Mätare

# IT-infrastruktur

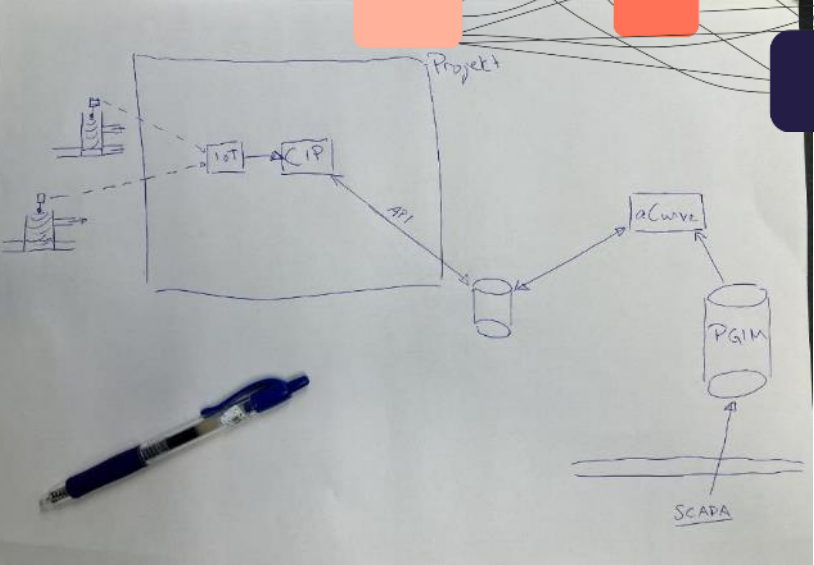
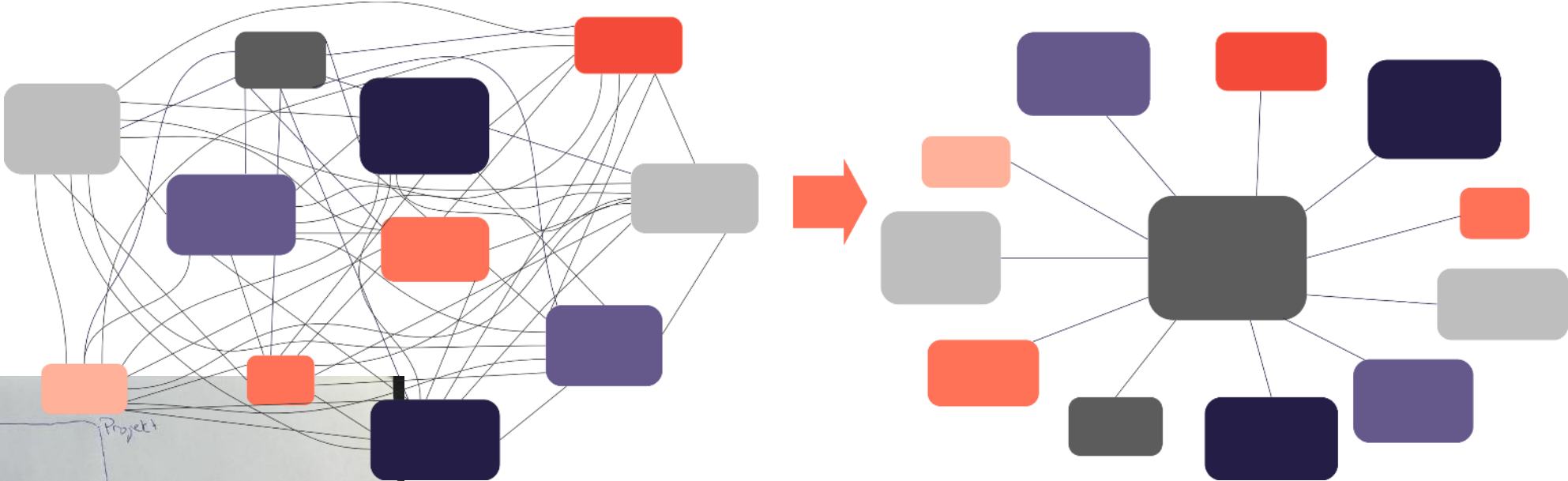

## **Kontakt**

**Glen Nivert**

**Kretslopp och vatten Göteborgs stad**

**[glen.nivert@kretsloppochvatten.goteborg.se](mailto:glen.nivert@kretsloppochvatten.goteborg.se)**